



0-10V DIMMING WALL SWITCH SENSOR

LINE VOLTAGE

OVERVIEW

The **Intelligent Lighting Controls** family of wall switch occupancy/vacancy sensors provides a simple yet cost effective lighting control solution for many retrofit applications. Designed with contractors in mind, the **ILCO-10V** dimming wall switch sensor is significantly shallower than typical dimmers and sensors, resulting in less crowded wall boxes. Additionally, versatile wiring enables usage with or without a neutral and allows reversal of line and load connections. **ILC** products utilize the latest passive infrared technology and digital signal processing techniques to provide unmatched motion detection performance. These units are also available with an integrated microphone to provide overlapping passive acoustic occupancy detection for rooms with obstructions or where occupant motion is limited. For dimming adjustment, intuitive raise and lower buttons are present in a addition to an on/off button.

BASIC OPERATION

Sensors detect movement in the infrared energy that radiates from occupants as they move within the devices field-of-view. Once occupancy is identified, the sensor's internal relay switches power on to the connected lighting. All units can also be configured to operate in Vacancy Mode (e.g., require lights be manually switched on). Once lights are on and if equipped with passive dual technology (PIR/Acoustic), the unit's microphone is enabled to further enhance detection. An internal timer is set to keep lights on during brief periods of inactivity, and is reset every time occupancy is signaled by either the passive infrared or acoustic detection technologies. Ambient daylight detection can also be enabled in equipped units so that lights are held off in rooms with sufficient light contribution from windows or skylights.



SPECIFICATIONS

ELECTRICAL

OPERATING VOLTAGE
120/277 VAC, 50/60 Hz

LOAD RATINGS
MAX: 800W @ 120VAC
1200W @ 277VAC
MIN: None

LOAD TYPES
LED Driver/Lamps
CFL, Electronic/Magnetic Ballasts (Fluorescent)
Tungsten (Incandescent)

DIMMING COMPATIBILITY
0-10 VDC ballasts or drivers compliant
with IEC 60929 Annex E.2

DIMMING LOAD
- 50 mA (sink only)

ENVIRONMENTAL

OPERATING TEMP
32°F to 122°F (0°C to 50°C) - Standard
-40° F/C (with -HE Option)

RELATIVE HUMIDITY
0-95% Non-Condensing, Indoor Use Only

PHYSICAL

SIZE / WEIGHT
2.74"H x 1.68"W x 1.39"D
(6.96 x 4.27 x 3.53 cm)
Not Including Mounting Strap
4.5 oz

MOUNTING
Single Gang Switch Box



FEATURES

ELECTRICAL FEATURES

- Interchangeable Line & Load Wires - Impossible to Wire Backwards
- Accommodates Neutral (3-Wire) and No-Neutral (2-Wire) Installation
- Electronically Timed Switching Ensures Long Relay Life
- Compatible with 0-10V Dimmable LED, and Fluorescent Lighting
- Meets NEC 404.2(c) & 404.22 Guidelines Regarding Powering Over Ground & Current Leakage

PHYSICAL FEATURES

- Enclosure is 25-40% Shallower than Other Sensors (< 1" Depth into Wallbox)
- Unique Bat-Wing Shaped Lens Provides Enhanced Peripheral Detection
- Self-Grounding Mounting Strap
- Modern Look and Intuitive Easy-Tap Buttons for On/Off, Raise, & Lower
- Rugged Vandal Resistant Lens
- Settings are Adjustable Without Removing Cover Plate

OPERATIONAL FEATURES

- Wall-To-Wall Passive Infrared Small Motion Detection
- Passive Acoustic Detection (Optional) - Prevents False Offs when No Motion is Present
- 100% Passive Detection Methods - No Interference Potential from External Devices
- Configurable Sensor Settings Including Time Delays and Occupancy/Vacancy Operating Modes
- Configurable Dimming Parameters including High/Low Trims, Turn on Levels, and Curve Types
- Blue Locator LED when Lights are Off

COVERAGE PATTERNS

- 30" to 48" (0.76 - 1.22 m) recommended mounting height
- Wall to wall (~180 degree) coverage
- Small motion (e.g., hand movement) detection up to 20 ft (6.10 m), ~625 ft²
- Large motion (e.g., walking) detection greater than 36 ft (10.97 m), ~ 2025 ft²
- Overlapping acoustic detection of occupants over entire coverage area
- Advanced signal processing filters out nuisance noises while not effecting overall sensitivity

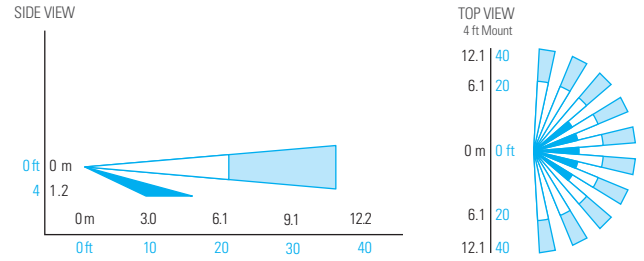

APPLICATIONS

A wall switch sensor is typically used to retrofit an existing wall switch in a small room or enclosed space. A Passive Infrared (PIR) only sensor is sufficient for spaces where line of site is maintained and occupants are periodically moving (e.g., copy rooms, storage rooms). Dual technology sensors are necessary where occupants may be partially blocked from the sensor's direct view or where they may be stationary (e.g., private offices or restrooms with stalls).

- Private Restrooms
- Small Meeting Room
- Storage Room
- Copy Rooms
- Small Office
- Break Room
- Restroom with Stalls
- Vestibule

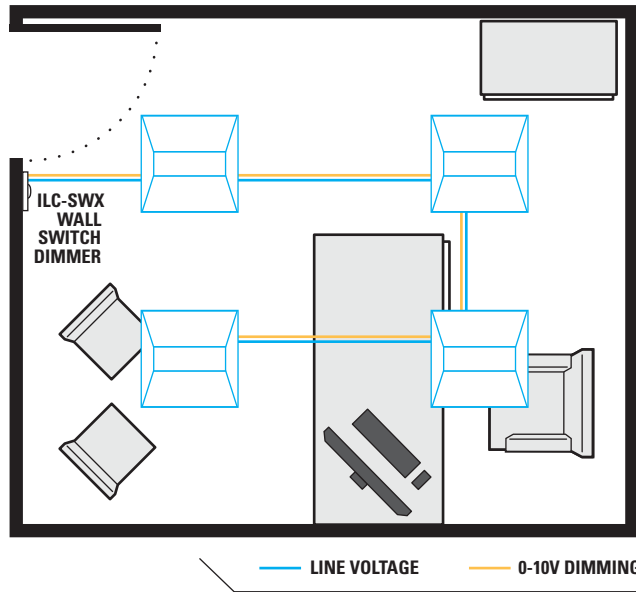

✓ CODE COMPLIANCE

This wall switch sensor can be used to meet many requirements of ASHRAE 90.1 (2016), IECC (2015), and Title 24 (2016).

- Occupancy Operation: Auto On/Auto Off
- Vacancy Operation: Manual On/Auto Off
- Partial On Operation:
 - Auto On to 50%
 - Users can raise or lower light level manually
 - Auto Off

ASHRAE®
STANDARD 90.1 - 2016

IECC®
2015 STANDARD



DIMMING APPLICATION TABLE

MODEL #	DETECTION TYPE		DEFAULT OPERATING MODE ^{1,2}	
	PIR	ACOUSTIC	NAME	DESCRIPTION
ILC-SWX-101-D	•		Partial On	Auto-On to 50%
ILC-SWX-103-D	•		Vacancy	Manual On to Last Level
ILC-SWX-111-D	•		Partial On	Auto-On to 50%
ILC-SWX-121-D	•	•	Partial On	Auto-On to 50%
ILC-SWX-123-D	•	•	Vacancy	Manual On to Last Level
ILC-SWX-131-D	•	•	Partial On	Auto-On to 50%

1. ALL MODES ARE ENERGY CODE COMPLIANT
2. MODES ON ALL UNITS ARE FIELD CONFIGURABLE

ORDERING INFO

SAMPLE MODEL # ILC-SWX-101-D-WH

	PRODUCT		DETECTION		DEFAULT OPERATIONAL MODE		DIMMING		COLOR ¹		ADDITIONAL OPTIONS	
ILC-SWX	Wall Switch Sensor	-1	Passive Infrared (PIR)	0	Auto On to 50% (Partial On)	1	0-10V	-D	White	-WH	None	Blank
			Passive Infrared (PIR) + Daylight	1	Manual On (Vacancy) ³	3	Dimming	Ivory	-IV	Humid Environment	-HE	
			Passive Dual Tech. (PIR/Acoustic)	2	Vacancy Only (CA Title 20/24) ³	4		Lt. Almond	-LA	10 Pack**	-J10	
			Passive Dual Tech. (PIR/Acoustic) + Daylight	3			Gray	-GY				
								Black	-BK			
								Red	-RD			

ACCESSORY		COLOR				
ILC-SWX-199	Single Gang Wall Plate	White	-WH	Gray	-GY	-J10
ILC-SWX-199-D-FACE	Sensor Face Color Change Kit	Ivory	-IV	Black	-BK	
		Light Almond	-LA	Red	-RD	

NOTE 1: WALLPLATE NOT INCLUDED
NOTE 2: THE CONTRACTOR PACK OPTION (-J10) REDUCES JOB SITE WASTE AND INVENTORY TIME
NOTE 3: DAYLIGHT FEATURES DISABLED IN VACANCY MODE

WIRING

- Unit works both in installations where neutral connection is available as well as installations where only ground connection is present.
- If no neutral is present, remove the white sleeve from the wire & connect the now Green/Yellow wire to ground (see diagram below).
- The White wire (or Green/Yellow wire underneath the removable sleeve) MUST be connected to neutral (or Ground if sleeve is removed) for the unit to operate.
- The all Green wire is just for safety.
- Never connect Violet or Gray wire to line voltage.
- The unit's two black wires are interchangeable (e.g., one connects to line power, one connects to load).

NEUTRAL TO GROUND WIRE CONVERSION DETAIL

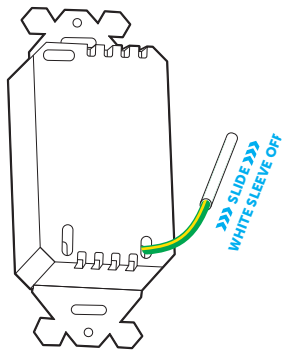

STANDARD WIRING

WALL SWITCH SENSOR w/ DIMMING

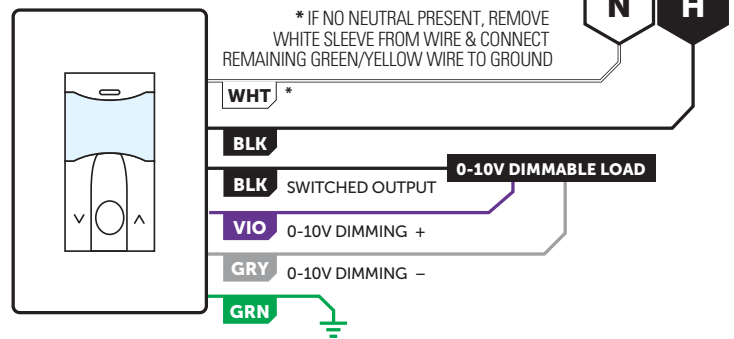

NOTE: This product is UL listed and meets NEC 404.2(c) & 404.22 guidelines regarding powering over ground & current leakage. Powering over ground is permitted for replacement / retrofit only.

3-WAY WIRING

TWO SENSORS IN PARALLEL

- Only one sensor can be model with 0-10V Dimming
- Both sensors must time out for lights to turn off (or both buttons must be switched)
- Recommended for Automatic On (Occupancy) applications only

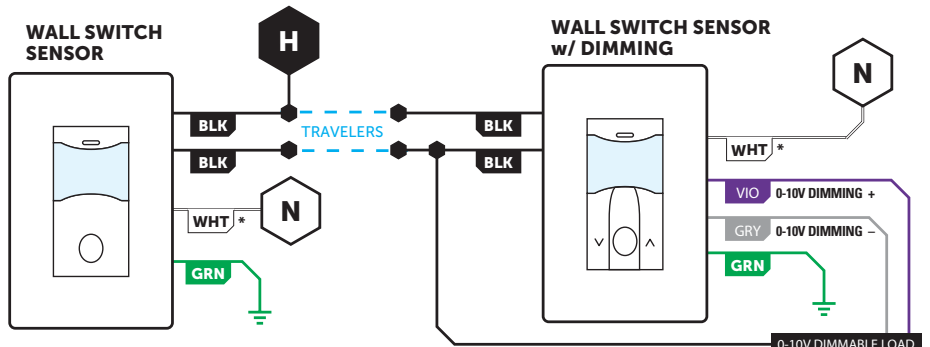

* IF NO NEUTRAL PRESENT, REMOVE WHITE SLEEVE FROM WIRE & CONNECT REMAINING GREEN/YELLOW WIRE TO GROUND

INSTALLATION

FRONT

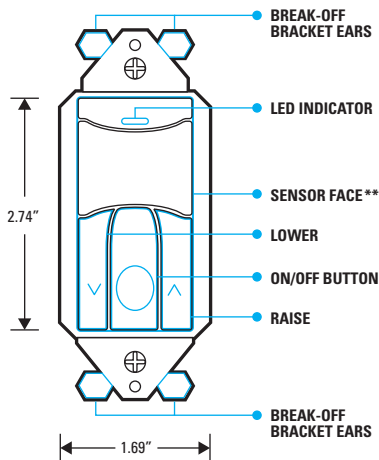

SIDE

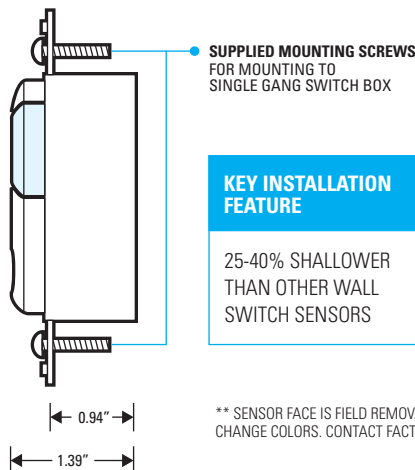

KEY INSTALLATION FEATURE

25-40% SHALLOWER THAN OTHER WALL SWITCH SENSORS

** SENSOR FACE IS FIELD REMOVABLE IN ORDER TO CHANGE COLORS. CONTACT FACTORY FOR ADDITIONAL FACES

OPERATION SETTINGS

TIME DELAY

- Test mode, 30 sec, 5-30 minutes
- 5 sec test mode expires after 10 minutes

HIGH-END & LOW-END TRIM

- High-end trim enables energy saving task tuning by setting a maximum level (100%-50%) that which users are allowed to raise lights
- Low-end trim enables minimum user level of dimmer to be raised

TURN ON/TURN OFF DIMMING OPERATION

- Sensor turns on lighting to last user level or a preset level (100%, 50%, or custom)
- Sensor can turn off lighting by switching off power (by opening relay) or dimming below electronic off level
- Lighting can also be held at low-end trim level during unoccupied/off state

FADE ON/FADE OFF TIMES

- Adjustable time for level to ramp up to turn-on level (0.75 sec, 1.5 sec, 3 sec, 5 sec, or 15 sec)
- Adjustable time interval for level to ramp down to off (0.75 sec, 1.5 sec, 3 sec, 5 sec, or 15 sec)

DIMMING CURVE

- The dimming curve defines how dimmers adjust their voltage output in response to button commands
- Linear (default), Square Law, Logarithmic

AMBIENT LIGHT (DAYLIGHT) DETECTION

- Sensor holds lights off when ambient light is present
- Manual threshold levels or auto-selection of threshold level
- Disabled when in Vacancy (Manual On) mode

TURN-ON SENSITIVITY

- When enabled, this setting reduces the sensor's PIR sensitivity for initial turn-ons in order to eliminate false on caused by reflective surfaces like windows
- Unit returns to full sensitivity after initial turn-on

OPERATIONAL MODES

SENSORWORX wall switch sensors are intelligent devices that provide both excellent energy savings and enhanced user convenience. Users can choose from several pre-programmed operational modes that best fit their preferences and applicable energy codes.

Vacancy Mode

Manual On / Automatic Off operation. Lights can also be switched off manually. This mode provides increased energy savings but requires the user to initially turn on the lights. Models SWX-103, SWX-104, SWX-123, and SWX-124 default to Vacancy modes.

Occupancy Mode

Automatic On and Automatic Off operation. If lights are switched off manually, the Automatic On functionality is temporarily disabled to allow the person a few seconds to leave the room before switching back to Automatic On operation. However, if the person remains in the space the unit will stay in a manual on state until the switch is pressed again. This mode is the default operation of SWX-101, SWX-111, SWX-121, and SWX-131 models.

Automatic On w/ Exit Time Mode

Automatic On and Automatic Off operation. If lights are switched off manually, the Automatic On functionality is disabled for a fixed 30 seconds.

Override Off Mode

Automatic On and Automatic Off operation until lights are switched off manually, at which point Automatic On functionality is disabled until the switch is pressed again.

Disabled Switch Mode

Automatic On and Automatic Off operation only. Switch functionality to manually turn on/off lights is disabled.

Presentation Mode

If lights are switched off manually, the Automatic On functionality is disabled until the space becomes unoccupied and the sensor's time delay expires.

LED FUNCTIONALITY

- White LED blinks upon occupancy detection
- Blue LED serves as a switch locator when lights are off
- LED functionality can be disabled

