



CEILING MOUNT OCCUPANCY SENSOR

LOW VOLTAGE

OVERVIEW

The **Intelligent Lighting Controls** family of ceiling mount occupancy sensors provides a range of control solutions for spaces with finished ceilings (e.g., tiles, sheetrock, and plaster). Preferred by contractors for their simple, yet flexible, mounting methods, **ILC** sensors reduce installation time and fuss. **ILC** products utilize the latest passive infrared technology and digital signal processing techniques to provide unmatched detection performance. Additionally, **ILC** units are available with an integrated microphone to provide overlapping passive acoustic occupancy detection for rooms with obstructions or where occupant motion will be limited. Enhanced options for this sensor family include a photocell that will override lights off if sufficient ambient light is present and an isolated relay for interfacing external systems (e.g., HVAC/BAS).

BASIC OPERATION

Sensors detect movement in the infrared energy that radiates from occupants as they move within the devices field-of-view. Once occupancy is identified, the sensor signals a connected power/relay pack to switch on the connected lighting. If equipped with passive dual technology (PIR/Acoustic), the unit's microphone is then also enabled to further enhance detection while the lights are on. An internal timer is set to keep lights on during brief periods of inactivity, and is reset every time occupancy is signaled by either the passive infrared or acoustic detection technologies.

APPLICATIONS

A single sensor can be used in small spaces like a private office, however, multiple low voltage sensors can be easily wired together to provide coverage for larger spaces like an open office.

- Classrooms
- Hallways
- Private Restrooms
- Open Areas
- Small Offices
- Break Rooms
- Conference Rooms
- Copy Rooms

FEATURES

- Digital Passive Infrared (PIR) Detection
- Passive Acoustic Detection (Optional)
- 360° Coverage Patterns
- Compact Size and Matte Finish
- Four Contractor Friendly Mounting Methods
- Mounting Nipple Attachment with Integrated Hole Saw
- Convenient Test Mode and Adjustable Time Delays
- Optional Photocell & Isolated Relay

SPECIFICATIONS

ELECTRICAL

OPERATING VOLTAGE
12-24 VAC/VDC

CURRENT DRAW
2mA (PIR models)
10mA (Dual Tech. models)

OUTPUT
Logic High VDC (Occupied Mode)

RECOMMENDED POWER PACK
ILC-SWX-900 Series

ISOLATED RELAY RATING
1A @ 30 VDC/VAC

ENVIRONMENTAL

OPERATING TEMP
32°F to 122°F (0°C to 50°C)

RELATIVE HUMIDITY
0-95% Non-Condensing,
Indoor Use Only

PHYSICAL

SIZE
4.00" Diameter x 1.25" H
(10.16 x 3.17 cm)

WEIGHT
4.75 oz

COLOR
White

OPERATION

TIME DELAYS
30 sec to 30 min
10 Minute Default

TEST MODE
5 sec

CODE COMPLIANCE

Sensors can be used to meet ASHRAE 90.1, IECC, & Title 24 energy code requirements



ORDERING INFO

SAMPLE MODEL # ILC-SWX-222-1

| | PRODUCT | | DETECTION | | COVERAGE | | VOLTAGE | | OPTIONS | |
|---------|----------------------|---|--|---|-------------------|----|-------------|---|--------------------------|----|
| ILC-SWX | Ceiling Mount Sensor | 2 | Passive Infrared (PIR) | 0 | Small Motion 360° | 1 | Low Voltage | 1 | Isolated Auxiliary Relay | AR |
| | | | Passive Infrared (PIR) + Photocell | 1 | Large Motion 360° | 2 | | | | |
| | | | Passive Dual Technology (PIR/Acoustic) | 2 | High Bay 360° | 3* | | | | |
| | | | Passive Dual Technology (PIR/Acoustic) + Photocell | 3 | | | | | | |

ACCESSORIES

ILC-SWX-299-JP - Ceiling Sensor Trim Ring for Mounting to Single Gang Mudring, Handy Box, or 4" Octagon Box

* Not available with Dual Tech units

COVERAGE

PASSIVE INFRARED (PIR)

- 8 to 15 ft (2.44 to 4.57 m) mounting height recommended for small and large motion lenses. For 15 to 40 ft (2.44 to 12.20 m) mounting heights use high bay lens.
- Detection range improves when walking across beams as compared to into beams
- Lenses can be swapped in field if necessary, contact technical support for assistance

SMALL MOTION 360°

- Best choice for detection of small motions from sitting occupants (e.g., hand motion)
- ~500 ft² of coverage

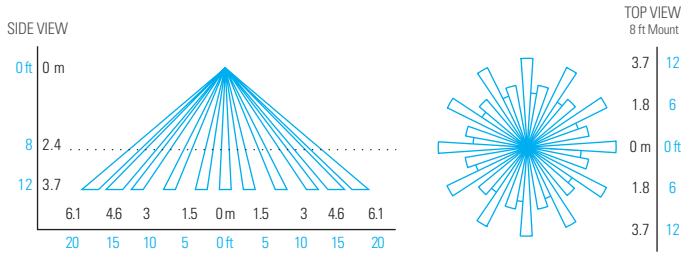

LARGE MOTION 360°

- Best choice for detection of larger motion (e.g., walking)
- ~2000 ft² of coverage
- One of the longer segments of the coverage pattern aligns with the screw hole axis on the sensor (shown as dotted line on Top View diagram below)

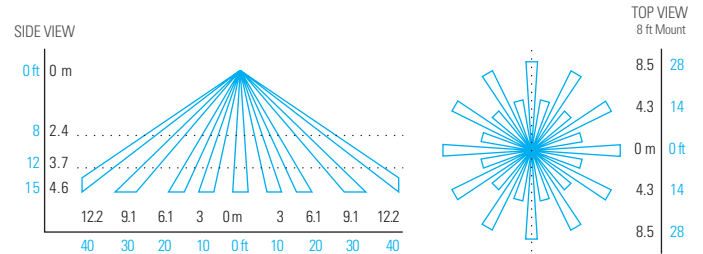

HIGH BAY 360°

- Best choice for mounting heights above 15ft
- Recommended for gyms, warehouses, and other high ceiling areas where multiple sensor coverage is required
- Not recommended for areas where occupants are sitting
- Gaps between outer segments get larger as mounting height increases
- Not available with acoustic (dual technology)

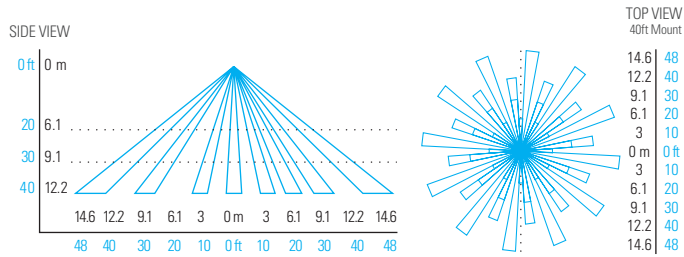

DUAL TECHNOLOGY (PIR/ACOUSTIC)

- Units with dual technology (ILC-SWX-221-1 and ILC-SWX-222-1) have overlapping acoustic detection of the complete PIR coverage area
- A PIR event is required to initially enable acoustic detection
- Sounds indicating occupancy reset the sensor's time delay while non-occupant noises are filtered out
- Occupant sounds alone will not keep lights on indefinitely, PIR motion must be periodically detected for lights to remain on for an extended time
- After sensor time out expires, acoustic detection remains enabled for 10 seconds to enable voice reactivation of lights for additional convenience and safety

WIRING

STANDARD WIRING

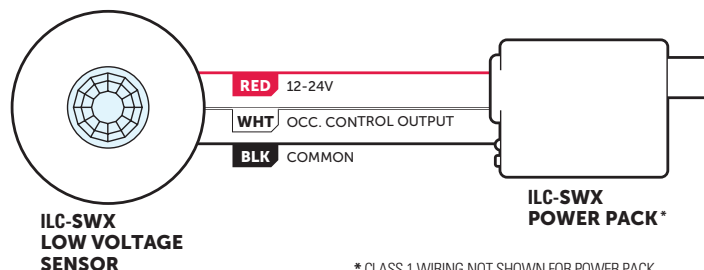

* CLASS 1 WIRING NOT SHOWN FOR POWER PACK

WIRING CONT.

SENSOR CONTROL OF SEPARATE OCCUPANCY & PHOTOCELL ZONES

- During occupied state, photocell output (blue wire) will turn lights off if ambient light level surpasses threshold and back on if level drops
- Also configurable to prevent lights from initially turning on, but not to turn them off once lights are on
- Configurable ambient light threshold levels or auto-selection

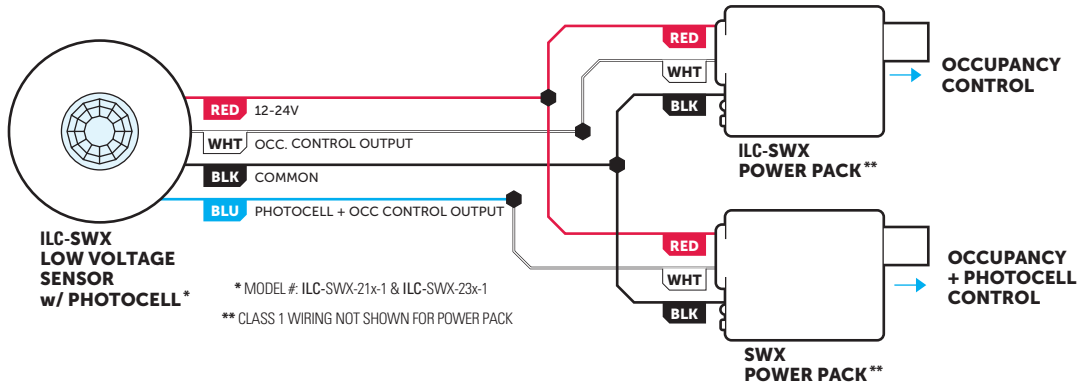

SENSOR INTERFACE TO BMS

- The auxiliary output relay (model option -AR) is designed to interface with many types of BMS, VAV units, and relay panels
- Operation of relay (brown wires) is configurable:
 - By default the relay latches closed when occupancy is detected (white wire goes high)
 - Relay can be configured to alternatively follow the occupancy + photocell (blue wire) output
 - Relay polarity (open vs closed) can also be reversed

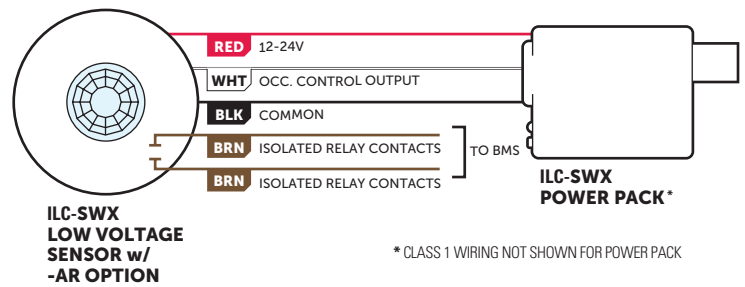

INSTALLATION OPTIONS

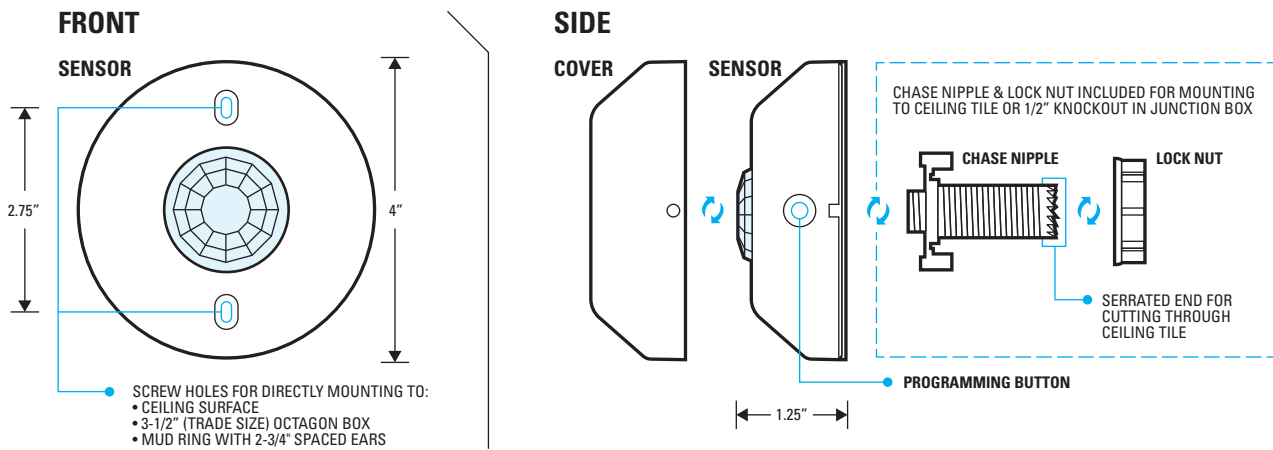

Note: If mounting to a Single Gang Mudring, Handy Box, or 4" Octagon Box, a trim ring is required. Part Number: **ILC-SWX-299-JP**.