

45 Degree Photo Sensor Head Details

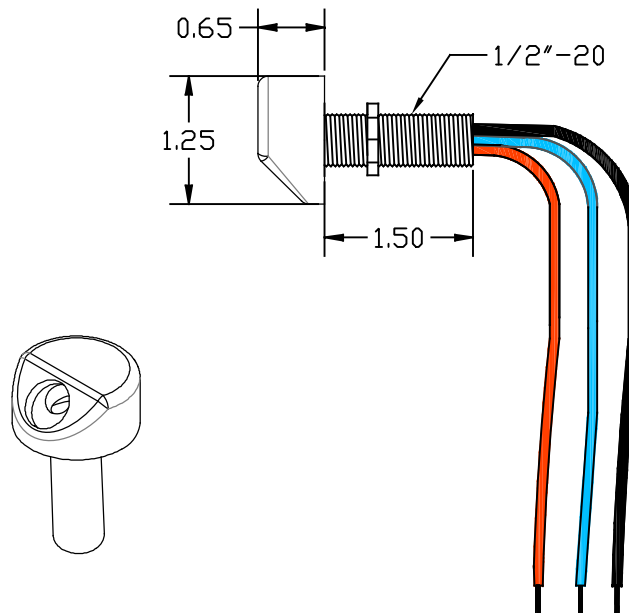

Description:

The 45 degree photocell sensor head interfaces with any of the ILC photocell controllers. The head is designed to measure natural daylight levels, convert these levels to a digital signal, and then send it back to the controller. The head is angled to point directly towards windows to limit any influence from artificial lighting.

Specifications:

- Designed to mount in a ceiling tile, sheet rock, or other surface
- White PVC material
- Head 1.25" Diameter x .65" Deep, 1/2"-20 x 1.50" threaded mount
- Nut provided
- 6" wire leads, 22 AWG
- Analog photocell to digital output

Connections:

Red: 5VDC positive
Black: 5VDC common
Blue: Digital signal

Operating Environment:

Location: Interior/Exterior space
Operating Temp: -35 to 50 deg. C
Humidity: 10% to 100% Condensing
Atmosphere: Non-explosive/corrosive
Vibration: Stationary