

LightSync Digital

Wall Sensor Color Change Kit



Overview

The LightSync Digital Wall Sensor Color Change Kit allows for simple field modification of a LSWS digital switch. The CCK comes as a complete assembly with pre-installed buttons to allow quick and easy replacement. The assembly will come ready to install by replacing the switch frame in your existing LSWS switch. The CCK is available in all colors White, Ivory, Gray, Black, Red and Light Almond; and all LSWS switch types Multi-Zone Dimmer, Scene, Scene Multi-Zone Dimmer, or Non-Dim.

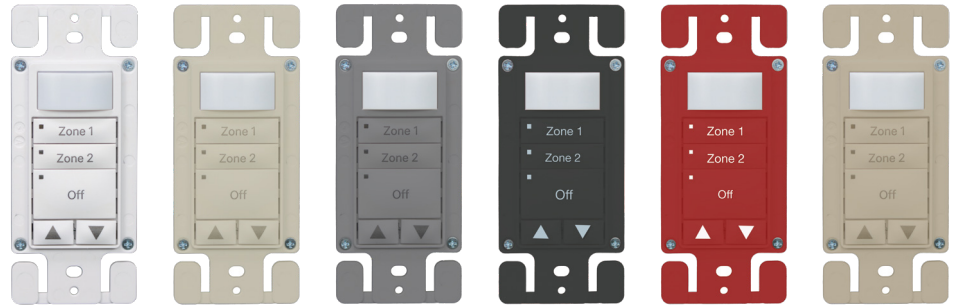

Actual colors may vary

Features

- **Made in the USA, meets BABA Requirements**
- **Change Kit** available in White, Ivory, Gray, Black, Red and Light Almond.
- **Switch frame with installed buttons** provided as an assembly.
- **Laser engraving is provided**, and custom engraving is available, Black and Red buttons are pad-printed.
- **Easy field installation**
- **1 to 3 button zone control configurations**
- **Multi-Zone Dimming** for up to 3 zones and All-Off
- **Scene Station** with dimming for up to 3 scenes and All-Off
- **Scene Multi-Zone-Dimming** for up to 3 Senses or Zones (3S/1Z, 2S/2Z or 1S/3Z)
- **Internal configuration** can be changed at the switch or with diagnostic tool

Warranty

Five-Year limited warranty

Ordering

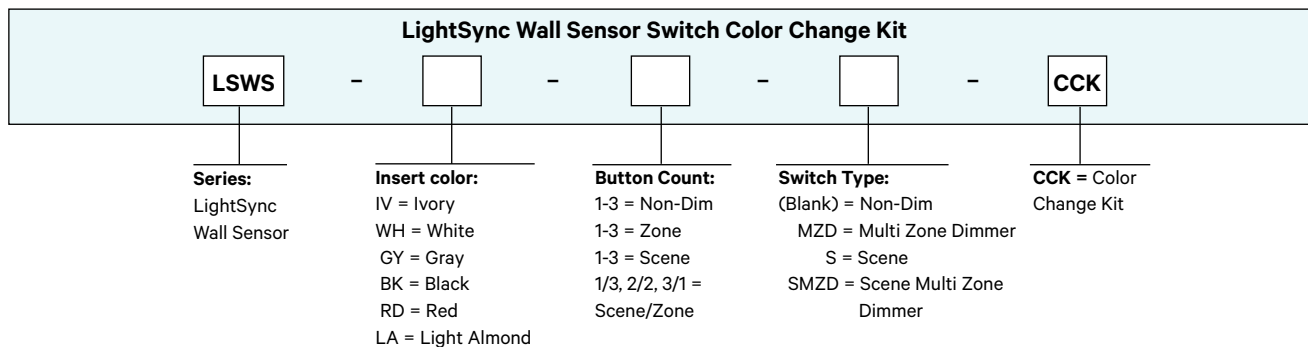

All ILC product configurations are built to be compliant with the Buy American Act of 1933 (BAA) or the Buy America Build America Act (BABA). BABA is the minimum Government compliance requirement for the Buy America Build America standards which is part of the Infrastructure and Investment Jobs Act (IIJA). Individual Government Agencies may have more stringent compliance standards. Please refer to the [DOMESTIC PREFERENCES](#) website or consult the CLS Domestic Preferences team for more information. Components shipped separately may be separately analyzed under domestic preference requirements.

LightSync Digital

Wall Sensor Color Change Kit

Physical

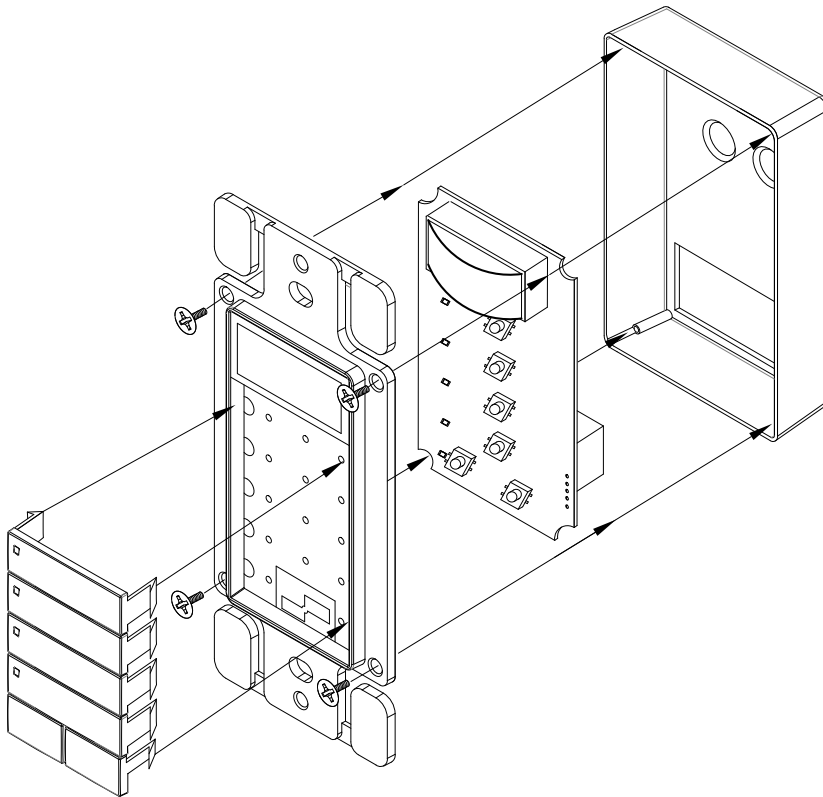

LSWS MZD Switch

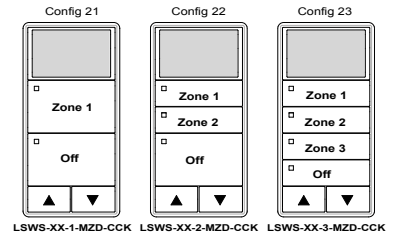

LSWS Scene Switch

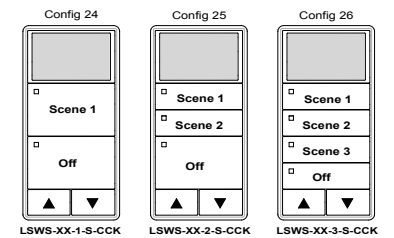

LSWS Scene/MZD Switch

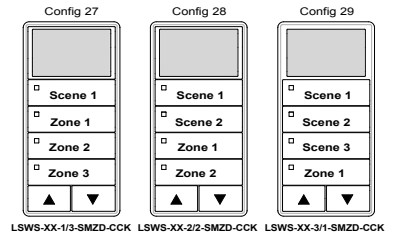

LSWS Non-Dim Stations

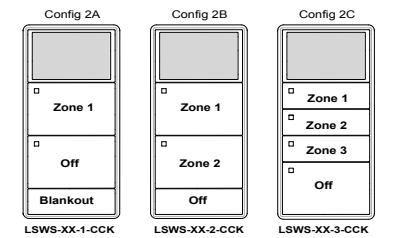

Specifications

Physical:

- Switch frame and button assembly
- Laser engraving standard as shown, Black and Red buttons are pad-printed
- Custom engraving available

Operating Environment:

- Location: Interior space
- Operating Temp.: 0° to 55° C
- Humidity: 10% - 90% Non-condensing
- Atmosphere: Non-explosive/corrosive
- Vibration: Stationary

Domestic Preferences:

Domestic preference options to meet BAA or BABA requirements. BABA is the minimum Government compliance requirement for the Buy America Build America standards which is part of the Infrastructure and Investment Jobs Act (IIJA). Individual Government Agencies may have more stringent compliance standards. Please refer to the [DOMESTIC PREFERENCES](#) website or consult the CLS Domestic Preferences team for more information. Components shipped separately may be separately analyzed under domestic preference requirements.

Certifications and Approvals:

- UL CUL
- FCC Part 15